

Introducción [ pag. 03 ]  
Kubic [ pag. 05 ]  
Kubic Cool [ pag. 17 ]  
Kubic Class [ pag. 25 ]  
Gama de producto [ pag. 30 ]

*Introduction [ pag. 03 ]*  
*Kubic [ pag. 05 ]*  
*Kubic Cool [ pag. 17 ]*  
*Kubic Class [ pag. 25 ]*  
*Product range [ pag. 30 ]*





Tras varias décadas creando un estilo de vida, Pomd'or sigue apostando por colecciones de accesorios y complementos de baño exclusivos y delicados.

El compromiso es seguir creando piezas únicas a través de un cuidado proceso de elaboración donde cada pieza transmite pasión por el detalle y obsesión por la calidad. Pomd'or consigue así emocionar y convertirse en una auténtica experiencia.

Ello se refleja en la autenticidad de Kubic, una colección que perdura en el tiempo y que se amplía con dos nuevas propuestas: Kubic Cool, que concentra la esencia de la colección pero con un aire más actual y versátil; y Kubic Class, piezas bellas y elegantes que consolidan el carácter más neoclásico.

*After several decades creating a lifestyle, Pom d'Or is still committed to its collections of exclusive and delicate bathroom accessories and fittings.*

*Our pledge is to continue creating unique pieces through a meticulous production process where every piece conveys a passion for detail and obsession for quality, enabling Pom d'Or to create excitement and emerge as an authentic experience.*

*This is reflected in the authenticity of Kubic, a collection that will last over time and that has been enhanced by two new projects: Kubic Cool, which concentrates the essence of the collection but with a more contemporary and versatile expression, and Kubic Class; beautiful and elegant pieces that consolidate its most neoclassical character.*





**KUBIC**  
AUTÉNTICA

La pasión. Los detalles. El irresistible sueño de dejar un legado único y genuino. La belleza de aquello concebido para que perdure ahora y siempre. Una colección cuyo sello de identidad transmite la autenticidad y delicadeza del saber hacer.

**KUBIC**  
AUTHENTIC

*Passion. Details. The irresistible dream of leaving behind a unique and genuine legacy. The beauty of something conceived to endure now and for ever. A collection whose symbol of identity is to convey the authenticity and delicacy of know-how.*





PORTATIL WC  
STANDS WC

36.19.04.002



PORTAPAPEL SIN TAPA  
*PAPER HOLDER WITHOUT COVER*

**36.14.81.002**





JABONERA ENCIMERA  
FREE STANDING SOAP DISH

36.60.52.002



PAPELERA CON TAPA  
WASTE BIN

36.93.51.002



COLGADOR  
HOOK

36.30.01.002



TOALLERO 60  
*TOWEL BAR 60*

36.10.60.002



JABONERA DUCHA  
SOAP DISH FOR BATHTUBE

36.60.20.002



**KUBIC COOL**  
INTERNACIONAL

Revisión actual de un clásico que concentra la esencia de la colección pero con un aire más actual. Se trata de líneas puras, piezas funcionales y diseño depurado. Un clásico contemporáneo adaptado a los gustos más internacionales y estilos más vanguardistas.

**KUBIC COOL**  
INTERNATIONAL

*An updated review of a classic that concentrates the essence of the collection with a more contemporary mood. Pure lines, functional pieces and purified design. A contemporary classic adapted to the most international tastes and cutting-edge styles.*





DOSIFICADOR ENCIMERA  
*FREE STANDING SOAP DISPENSER*

36.78.31.002



TOALLERO LATERAL DOBLE  
DOUBLE LATERAL TOWEL BAR

33.14.01.002



ASA  
*HAND GRIP*

36.05.36.002



PORTACEPILLOS ENCIMERA  
*FREE STANDING BRUSH-HOLDER*

36.70.50.002



PORTAPEPEL CON TAPA DERECHO  
*RIGHT PAPER HOLDER WITH COVER*

36.40.05.002



ESCOBILLERO  
*TOILET BRUSH*

36.90.02.002



TOALLERO ARO  
TOWEL RING

33.20.57.002

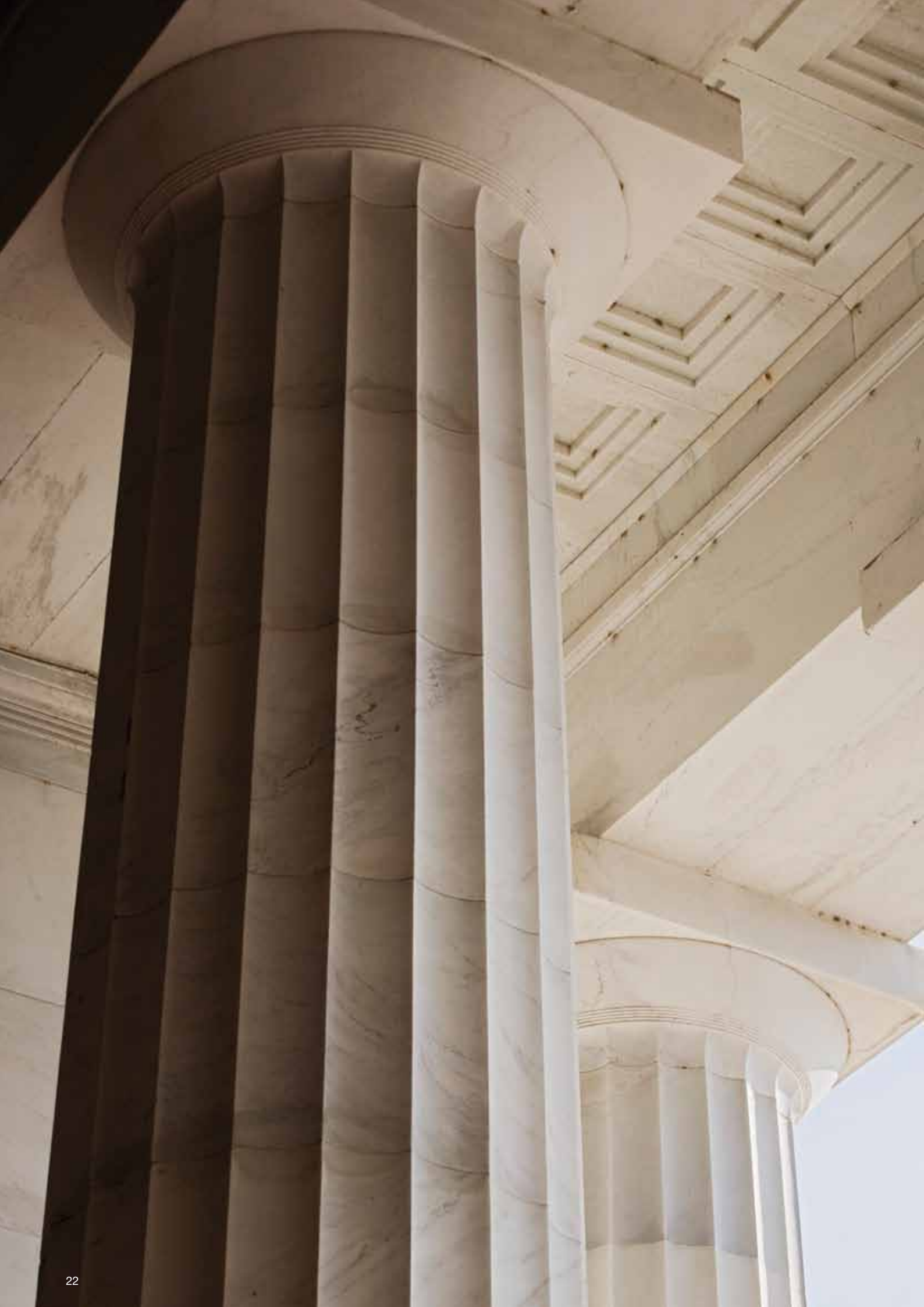

**KUBIC CLASS**  
ELEGANCIA

Piezas bellas y elegantes con un diseño refinado que consolida el carácter más neoclásico de esta colección. Sensualidad y perfección que combinadas con elementos de suaves formas resaltan el estilo más exclusivo.

**KUBIC CLASS**  
ELEGANCE

*Beautiful and elegant and pieces whose refined design consolidates the neoclassical nature of this collection. Sensuality and perfection that, combined with its smoothly formed elements, accentuate its most exclusive style.*





PORTAPAPEL SIN TAPA  
*PAPER HOLDER WITHOUT COVER*

43.14.81.002



COLGADOR  
HOOK

43.30.11.002



CAJA KLEENEX  
TISSUE BOX

36.94.02.002



TOALLERO ESTANTE  
*TOWEL RACK SHELF*

43.51.10.002



TOALLERO DE PIE  
FREE STANDING TOWEL BAR

36.12.04.002



ESTANTE 60  
*SHELF 60*

43.50.60.002



TOALLERO DOBLE 60  
*DOUBLE TOWEL BAR 60*

43.14.42.002

Kubic

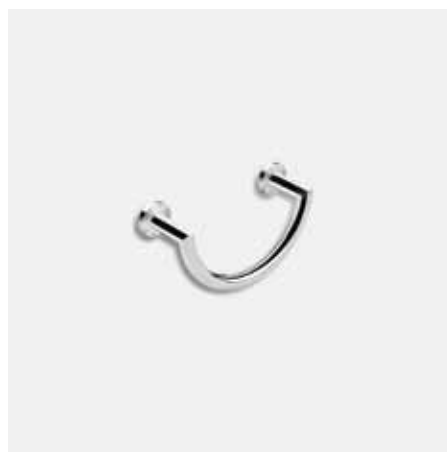
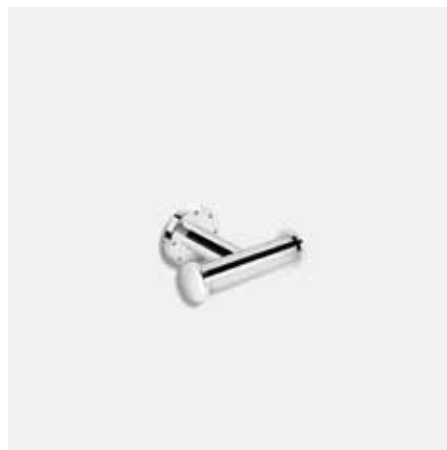
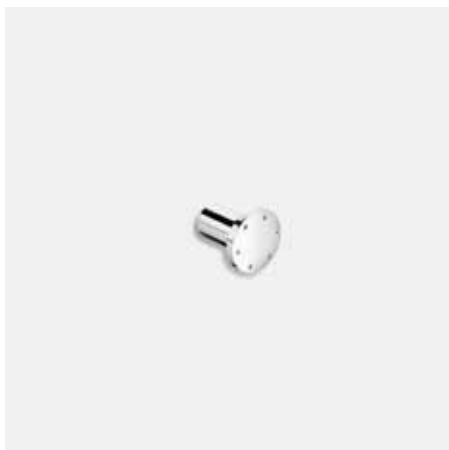

COLGADOR  
HOOK  
36.30.11 ●

COLGADOR  
HOOK  
36.30.01 ●

COLGADOR DOBLE  
DOUBLE HOOK  
36.30.02 ●

TOALLERO 60  
TOWEL BAR 60  
36.10.60 ●

TOALLERO 50  
TOWEL BAR 50  
36.10.50 ●

TOALLERO 40  
TOWEL BAR 40  
36.10.40 ●

TOALLERO 30  
TOWEL BAR 30  
36.10.30 ●

TOALLERO DOBLE 60  
DOUBLE TOWEL BAR 60  
36.14.42 ●

TOALLERO ARO  
TOWEL RING  
36.20.55 ●

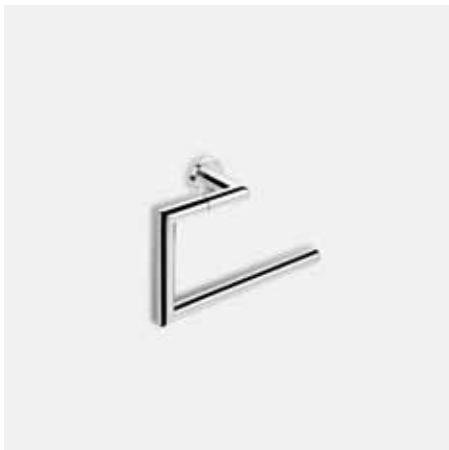

TOALLERO ARO  
TOWEL RING  
36.20.57 ●

TOALLERO LATERAL DOBLE  
DOUBLE LATERAL TOWEL BAR  
36.14.01 ●

TOALLERO ESTANTE  
TOWEL RACK SHELF  
36.51.10 ●

TOALLERO DE PIE  
FREE STANDING TOWEL BAR  
36.12.04 ●

COLGADOR DE PIE  
FREE STANDING HANGER  
36.31.02 ●

ESTANTE 60  
SHELF 60  
36.50.60 ●

ESTANTE 40  
SHELF 40  
36.50.40 ●

JABONERA DUCHA  
SOAP DISH FOR BATHTUBE  
36.60.20 ●

JABONERA RINCÓN  
CORNER SOAP DISH  
36.60.32 ●

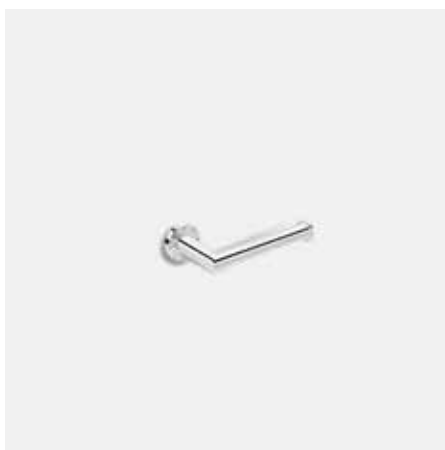

ASA  
HAND GRIP  
36.05.36 ●

PORTAPAPEL SIN TAPA  
PAPER HOLDER WITHOUT COVER  
36.14.81 ●

PORTAPAPEL CON TAPA DERECHO  
RIGHT PAPER HOLDER WITH COVER  
36.40.05 ●

PORTAPAPEL CON TAPA IZQUIERDO  
LEFT PAPER HOLDER WITH COVER  
36.40.12 ●

PORTAPAPEL RESERVA  
RESERVE PAPER HOLDER  
36.40.42 ●

ESCOBILLERO  
TOILET BRUSH  
36.90.02 ●

ESCOBILLERO SUELO  
FREE STANDING TOILET BRUSH  
36.90.51 ●

PORTATIL WC  
STANDS WC  
36.19.04 ●

PORTACEPILLOS  
BRUSH-HOLDER  
36.70.02 ●



DOSIFICADOR  
SOAP DISPENSER  
36.78.05 ●

JABONERA  
SOAP DISH  
36.60.03 ●

PORTACEPILLOS ENCIMERA  
FREE STANDING BRUSH-HOLDER  
36.70.52 ●

PORTACEPILLOS ENCIMERA  
FREE STANDING BRUSH-HOLDER  
36.70.50 ●

DOSIFICADOR ENCIMERA  
FREE STANDING SOAP DISPENSER  
36.78.32 ●

DOSIFICADOR ENCIMERA  
FREE STANDING SOAP DISPENSER  
36.78.31 ●

JABONERA ENCIMERA  
FREE STANDING SOAP DISH  
36.60.52 ●

CAJA KLEENEX  
TISSUE BOX  
36.94.02 ●

PAPELERA CON TAPA  
WASTE BIN  
36.93.51 ●



ESPEJO 60x100  
*MIRROR 60x100*  
**36.80.51.050**

ESPEJO 40x85  
*MIRROR 40x85*  
**36.80.50.050**

Kubic Cool

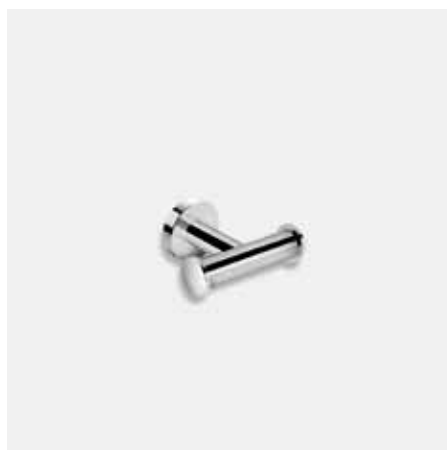
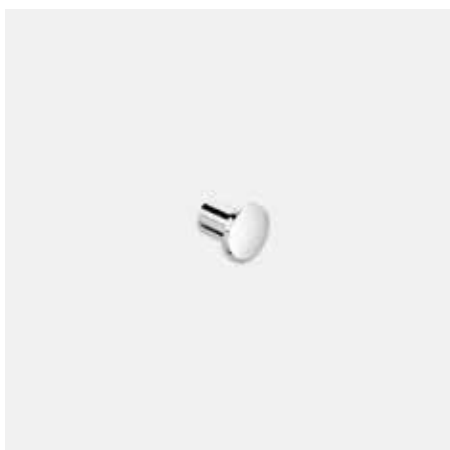

COLGADOR  
HOOK  
33.30.11 ●

COLGADOR  
HOOK  
33.30.01 ●

COLGADOR DOBLE  
DOUBLE HOOK  
33.30.02 ●

TOALLERO 60  
TOWEL BAR 60  
33.10.60 ●

TOALLERO 50  
TOWEL BAR 50  
33.10.50 ●

TOALLERO 40  
TOWEL BAR 40  
33.10.40 ●

TOALLERO 30  
TOWEL BAR 30  
33.10.30 ●

TOALLERO DOBLE  
DOUBLE TOWEL BAR  
33.14.42 ●

TOALLERO ARO  
TOWEL RING  
33.20.55 ●

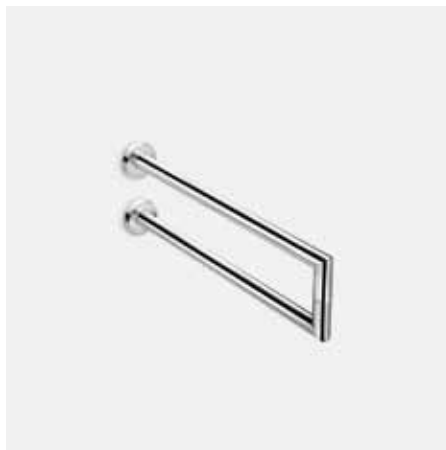

TOALLERO ARO  
TOWEL RING  
33.20.57 ●

TOALLERO LATERAL DOBLE  
DOUBLE LATERAL TOWEL BAR  
33.14.01 ●

TOALLERO ESTANTE  
TOWEL RACK SHELF  
33.51.10 ●

TOALLERO DE PIE  
FREE STANDING TOWEL BAR  
36.12.04 ●

COLGADOR DE PIE  
FREE STANDING HANGER  
36.31.02 ●

ESTANTE 60  
SHELF 60  
33.50.60 ●

ESTANTE 40  
SHELF 40  
33.50.40 ●

JABONERA DUCHA  
SOAP DISH FOR BATH TUBE  
33.60.20 ●

JABONERA RINCÓN  
CORNER SOAP DISH  
36.60.32 ●



ASA  
HAND GRIP  
36.05.36 ●

PORTAPAPEL SIN TAPA  
PAPER HOLDER WITHOUT COVER  
33.14.81 ●

PORTAPAPEL CON TAPA DERECHO  
RIGHT PAPER HOLDER WITH COVER  
36.40.05 ●

PORTAPAPEL CON TAPA IZQUIERDO  
LEFT PAPER HOLDER WITH COVER  
36.40.12 ●

PORTAPAPEL RESERVA  
RESERVE PAPER HOLDER  
33.40.42 ●

ESCOBILLERO  
TOILET BRUSH  
36.90.02 ●

ESCOBILLERO SUELO  
FREE STANDING TOILET BRUSH  
36.90.51 ●

PORTATIL WC  
STANDS WC  
36.19.04 ●

PORTACEPILLOS  
BRUSH-HOLDER  
36.70.02 ●



DOSIFICADOR  
SOAP DISPENSER  
36.78.05 ●

JABONERA  
SOAP DISH  
36.60.03 ●

PORTACEPILLOS ENCIMERA  
FREE STANDING BRUSH-HOLDER  
36.70.52 ●

PORTACEPILLOS ENCIMERA  
FREE STANDING BRUSH-HOLDER  
36.70.50 ●

DOSIFICADOR ENCIMERA  
FREE STANDING SOAP DISPENSER  
36.78.32 ●

DOSIFICADOR ENCIMERA  
FREE STANDING SOAP DISPENSER  
36.78.31 ●

JABONERA ENCIMERA  
FREE STANDING SOAP DISH  
36.60.52 ●

CAJA KLEENEX  
TISSUE BOX  
36.94.02 ●

PAPELERA CON TAPA  
WASTE BIN  
36.93.51 ●



ESPEJO 60 x100  
*MIRROR 60x100*  
**36.80.51.050**

ESPEJO 40x85  
*MIRROR 40x85*  
**36.80.50.050**

Kubic Class



COLGADOR  
HOOK  
43.30.11 ●

COLGADOR  
HOOK  
43.30.01 ●

COLGADOR DOBLE  
DOUBLE HOOK  
43.30.02 ●

TOALLERO 60  
TOWEL BAR 60  
43.10.60 ●

TOALLERO 50  
TOWEL BAR 50  
43.10.50 ●

TOALLERO 40  
TOWEL BAR 40  
43.10.40 ●

TOALLERO 30  
TOWEL BAR 30  
43.10.30 ●

TOALLERO DOBLE  
DOUBLE TOWEL BAR  
43.14.42 ●

TOALLERO ARO  
TOWEL RING  
43.20.55 ●

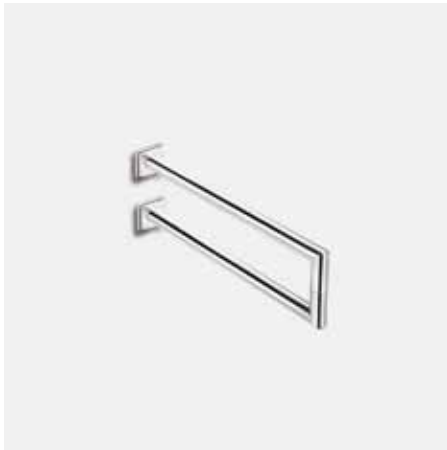

TOALLERO ARO  
TOWEL RING  
43.20.57 ●

TOALLERO LATERAL DOBLE  
DOUBLE LATERAL TOWEL BAR  
43.14.01 ●

TOALLERO ESTANTE  
TOWEL RACK SHELF  
43.51.10 ●

TOALLERO DE PIE  
FREE STANDING TOWEL BAR  
36.12.04 ●

COLGADOR DE PIE  
FREE STANDING HANGER  
36.31.02 ●

ESTANTE 60  
SHELF 60  
43.50.60 ●

ESTANTE 40  
SHELF 40  
43.50.40 ●

JABONERA DUCHA  
SOAP DISH FOR BATHTUBE  
43.60.20 ●

JABONERA RINCÓN  
CORNER SOAP DISH  
36.60.32 ●



ASA  
HAND GRIP  
36.05.36 ●

PORTAPAPEL SIN TAPA  
PAPER HOLDER WITHOUT COVER  
43.14.81 ●

PORTAPAPEL CON TAPA DERECHO  
RIGHT PAPER HOLDER WITH COVER  
36.40.05 ●

PORTAPAPEL CON TAPA IZQUIERDO  
LEFT PAPER HOLDER WITH COVER  
36.40.12 ●

PORTAPAPEL RESERVA  
RESERVE PAPER HOLDER  
43.40.42 ●

ESCOBILLERO  
TOILET BRUSH  
36.90.02 ●

ESCOBILLERO SUELO  
FREE STANDING TOILET BRUSH  
36.90.51 ●

PORTATIL WC  
STANDS WC  
36.19.04 ●

PORTACEPILLOS  
BRUSH-HOLDER  
36.70.02 ●



DOSIFICADOR  
SOAP DISPENSER  
36.78.05 ●

JABONERA  
SOAP DISH  
36.60.03 ●

PORTACEPILLOS ENCIMERA  
FREE STANDING BRUSH-HOLDER  
36.70.52 ●

PORTACEPILLOS ENCIMERA  
FREE STANDING BRUSH-HOLDER  
36.70.50 ●

DOSIFICADOR ENCIMERA  
FREE STANDING SOAP DISPENSER  
36.78.32 ●

DOSIFICADOR ENCIMERA  
FREE STANDING SOAP DISPENSER  
36.78.31 ●

JABONERA ENCIMERA  
FREE STANDING SOAP DISH  
36.60.52 ●

CAJA KLEENEX  
TISSUE BOX  
36.94.02 ●

PAPELERA CON TAPA  
WASTE BIN  
36.93.51 ●



ESPEJO 60x100  
*MIRROR 60x100*  
**36.80.51.050**

ESPEJO 40x85  
*MIRROR 40x85*  
**36.80.50.050**

